

**High Pressure Washer Operator Manual**

Overview .....	2
Precautions .....	2-4
Assembly Instructions .....	4
Operating Instructions .....	5
Using the Accessories .....	6
Working with Detergents .....	7
Shut Down and Clean-Up .....	8
Taking a Break .....	8
Winterizing and Long-Term Storage .....	8
Optional Cleaning Accessories .....	9
Troubleshooting .....	11-12

**Specifications**

Max. Pressure	1150 PSI
Max. Water Volume	1.8 GPM
Voltage	120 V
Amp Draw	13 AMPS

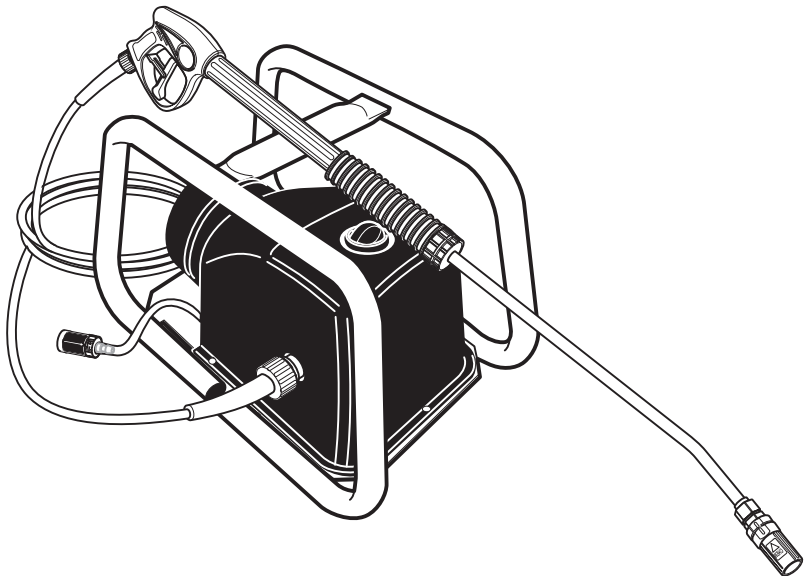

**Please keep the original box, packaging and receipt.  
Before operating this unit, please read this manual  
thoroughly and retain it for future reference.**

## OVERVIEW High Pressure Washer

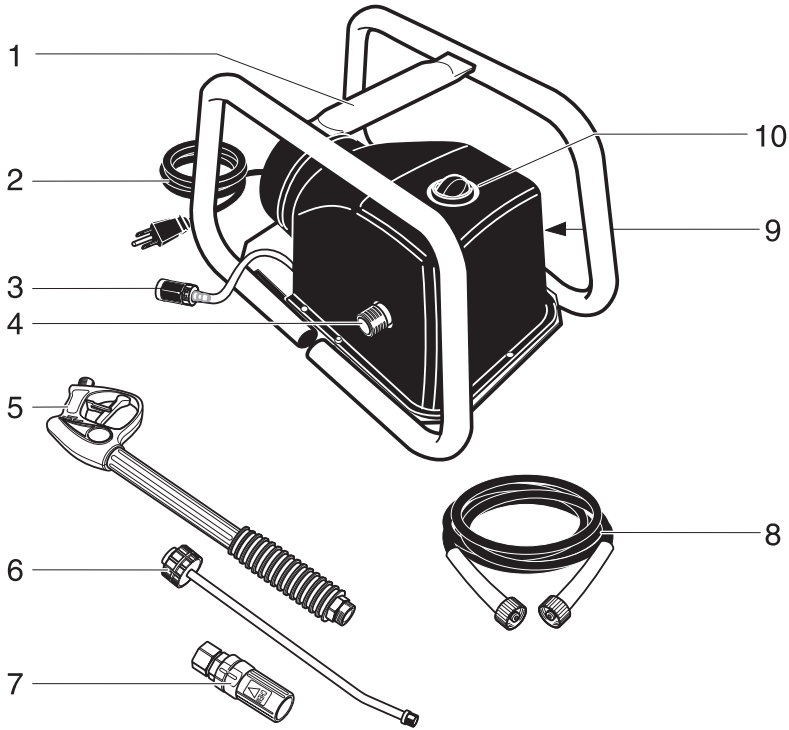

2

### Machine includes

- |                                     |                              |
|-------------------------------------|------------------------------|
| 1 Handle                            | 6 Spray wand                 |
| 2 Power cord                        | 7 Triple jet nozzle          |
| 3 Detergent filter and suction tube | 8 High pressure hose         |
| 4 High pressure outlet              | 9 Water inlet (not pictured) |
| 5 Trigger gun with safety lock      | 10 On/Off switch             |

## NEVER!

- Never point nozzle at people or animals.
- Never drink alcohol or use drugs while operating this equipment.
- Never operate while standing in water.
- Never touch plug with wet hands.
- Never let electrical connections rest in water.
- Never operate pressure washer without the water turned on.
- Never use hot water.

**THE BEST ANTI-FREEZE PROTECTION IS PROVIDED BY USING AND STORING THE MACHINE IN SHELTERED SPACE.**

## IMPORTANT PRECAUTIONS – *Read First!*



### Safety Warnings

*When using this product basic precautions should always be followed:*

- Read all the instructions before using the product.
- High pressure jets can be dangerous if subject to misuse. The jet must not be directed at persons, animals, electrical devices, or the machine itself.
- To reduce the risk of injury, do not operate the machine near children.
- Learn how to stop the machine and release pressure quickly. Be thoroughly familiar with the controls.
- Stay alert — watch what you are doing.
- Wear safety goggles.
- Do not use acids, solvents, or any other flammable material in this product. These products can cause physical injuries to the operator and irreversible damage to the machine.
- Do not operate the product when fatigued or under the influence of alcohol or drugs.
- Do not stand on unstable surfaces. Stand with both feet balanced at all times.
- To reduce the risk of electrocution, keep all connections dry and off the ground. Do not touch plug with wet hands.
- The Trigger Gun Safety Lock PREVENTS the trigger from accidentally being engaged. This safety feature DOES NOT lock trigger in the on position.

### WARNING

- DO NOT USE WITH FLAMMABLE LIQUIDS AND TOXIC CHEMICALS.
- INJECTION HAZARD: EQUIPMENT CAN CAUSE SERIOUS INJURY IF THE SPRAY PENETRATES THE SKIN. DO NOT POINT THE GUN AT ANYONE OR ANY PART OF THE BODY. IN CASE OF PENETRATION SEEK MEDICAL AID IMMEDIATELY.
- THIS SYSTEM IS CAPABLE OF PRODUCING 1150 PSI. TO AVOID RUPTURE AND INJURY, DO NOT OPERATE THIS PUMP WITH COMPONENTS RATED LESS THAN 1150 PSI WORKING PRESSURE (INCLUDING BUT NOT LIMITED TO SPRAY GUNS, HOSE AND HOSE CONNECTIONS).
- BEFORE SERVICING, CLEANING OR REMOVAL OF ANY PARTS, SHUT OFF POWER AND RELIEVE PRESSURE.
- DO NOT SPRAY ELECTRICAL APPARATUS AND WIRING.
- IF CONNECTION IS MADE TO A POTABLE WATER SYSTEM, THE SYSTEM SHALL BE PROTECTED AGAINST BACKFLOW.

### GROUNDING INSTRUCTIONS

This product must be grounded. If it should malfunction or breakdown, grounding provides a path of least resistance for electric current to reduce the risk of electric shock. This product is equipped with a cord having an equipment-grounding conductor and a grounding plug. The plug must be plugged into an appropriate outlet that is properly installed and grounded in accordance with all local codes and ordinances.

**DANGER** – Improper connection of the equipment-grounding conductor can result in a risk of electrocution. Check with a qualified electrician or service personnel if you are in doubt as to whether the outlet is properly grounded. Do not modify the plug provided with the product – If it will not fit the outlet, have a proper outlet installed by a qualified electrician. Do not use any type of adaptor with this product.

### Extension Cords

Use a sufficient gauge:

Up to 25 ft = 12/3 AWG

25 to 50 ft = 10/3 AWG

Use only 3-wire extension cords that have 3-prong grounding-type plugs and 3-pole cord connectors that accept the plug from the product. Use only extension cords that are intended for outdoor use. These extension cords are identified by a marking “Acceptable for use with outdoor appliances; store indoors while not in use.” Use only extension cords having an electrical rating not less than the rating of the product. Do not use damaged extension cords. Examine extension cord before using and replace if damaged. Do not abuse extension cord and do not yank on any cord to disconnect. Keep cord away from heat and sharp edges. Always disconnect the extension cord from the receptacle before disconnecting the product from the extension cord.



### Caution

- Follow the maintenance instructions specified in the manual.
- This machine has been designed for use with cleaning detergent supplied or recommended by the manufacturer. The use of other cleaning detergents may affect the operation of the machine and void the warranty.

## IMPORTANT PRECAUTIONS – *continued*

### Water Supply (Cold Water Only)

- Water hose must be at least a 1/2 inch or 5/8 inch in diameter.
- Flow rate of water supply must not fall below 2 GPM (gallons per minute).
- Flow rate can be determined by running the water for one minute into an empty 5-gallon container.
- The water supply temperature must not exceed 104°F/40°C.
- Never use the pressure washer to draw in water contaminated with solvents, e.g. paint thinners, gasoline, oil, etc.  
**NOTE:** Dirt in the feed water will damage the unit. To avoid this risk, we recommend fitting a water filter.
- Always prevent debris from being drawn into the unit by using a clean water source and an accessory water filter if required.

## ASSEMBLY INSTRUCTIONS

4

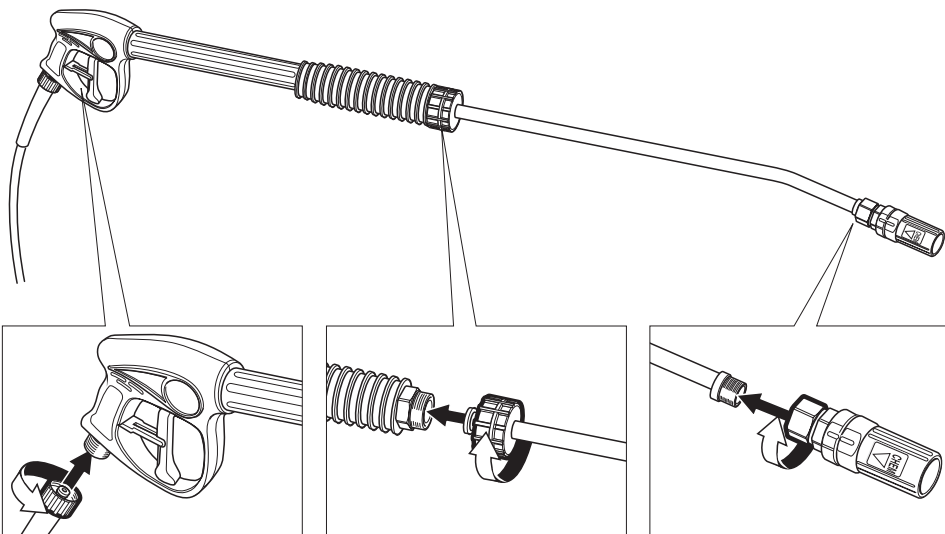

Step 1  
Attach the high pressure hose  
to the spray gun.

Step 2  
Attach the wand to the  
spray gun.

Step 3  
Attach the triple jet nozzle  
to the wand.

# OPERATING INSTRUCTIONS

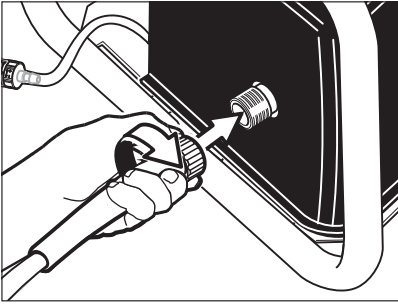

Step 1  
Connect the high pressure hose to the unit's high pressure outlet.

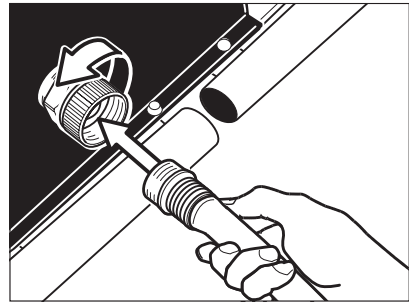

Step 2  
Connect water supply hose to unit's water inlet.

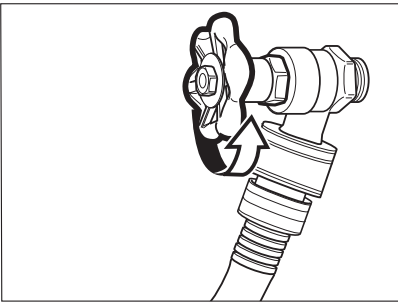

Step 3  
Connect water supply hose to the cold water source and turn water on completely.

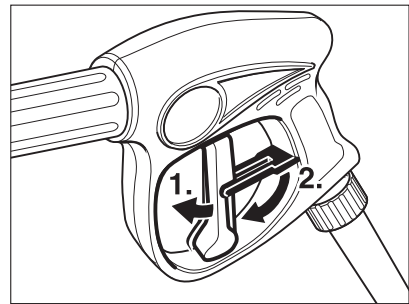

Step 4  
Plug the power cord into the power outlet.  
Unlock the lock of the trigger gun.

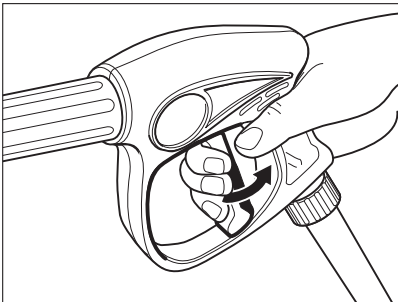

Step 5  
Trigger the gun to eliminate trapped air, wait for a steady flow of water to emerge from the spray nozzle.

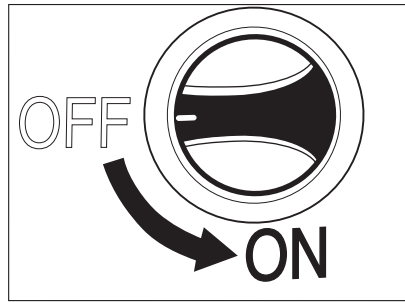

Step 6  
Turn on the pressure washer (**ON**).  
**NOTE:** This unit is equipped with a pressure switch. The motor only starts up when the trigger on the gun is pulled. The motor shuts off when the trigger is released.

## USING THE ACCESSORIES

### Triple Jet Nozzle

The triple jet nozzle must be positioned to one of the two settings for high pressure cleaning by turning the nozzle tip.

The pencil jet spray (0°) should be used for stubborn dirt.

The High pressure flat spray (25°) should be used for cleaning over a large surface area.

The third setting on the triple nozzle is used for the application of detergents.



### Warning

**TO AVOID SERIOUS INJURY, NEVER POINT SPRAY NOZZLE AT YOURSELF, OTHER PERSONS OR ANIMALS.**

6

*High pressure pencil jet cleaning.*

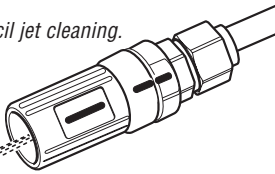

*High pressure fan jet cleaning.*

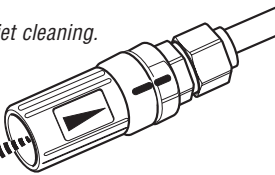

*Low pressure Detergent application  
"CHEM" position.*

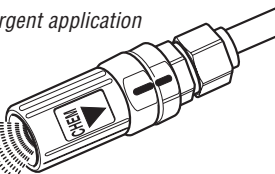

# WORKING WITH DETERGENTS

The high pressure setting is used for cleaning, you cannot apply detergents when working at high pressure. To apply detergents you must be operating at low pressure ("CHEM" position).

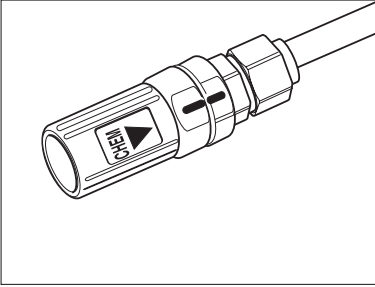

**Step 1**  
Use triple nozzle, set to "CHEM" position, to apply detergents

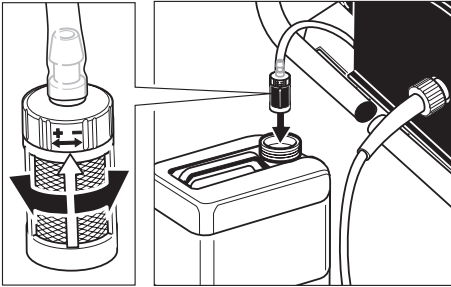

**Step 2**  
Adjust the filter end of the detergent tube for light (-), or maximum (+) detergent coverage. Place the filter end of detergent suction tube into the jug.

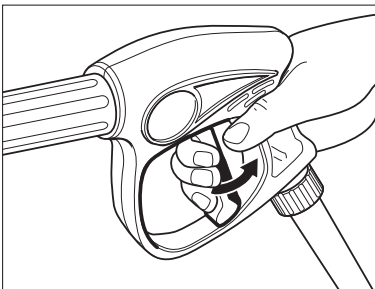

**Step 3**  
Turn on the pressure washer. Pull trigger to operate unit: Liquid detergent is drawn into the unit and mixed with water. Apply detergent to work area, from bottom to top. Do not allow detergent to dry on surface.

## Always Use Kärcher Detergents for Best Results.

Kärcher biodegradable detergents are specially formulated to protect the environment and your pressure washer. Special formula won't clog the suction tube filter and will protect the internal parts of the pressure washer for a longer life. For Kärcher Detergents, check with your dealer or call:

**1-888-705-9444**

The following detergents are available from your Kärcher dealer:  
**Premium Vehicle Wash**  
**Heavy Duty Degreaser**  
**Universal Detergent**



## Caution

Never use:

- Bleach, chlorine products and other corrosive chemicals
- Liquids containing solvents (i.e., paint thinners, gasoline, oils)
- Tri-sodium phosphate products
- Ammonia products
- Acid-based products

**These chemicals will harm the unit and will damage the surface being cleaned.**

## SHUTTING DOWN & CLEAN-UP

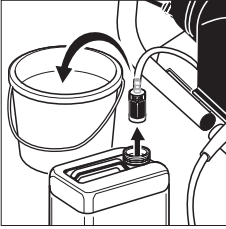

**Step 1**  
Remove detergent suction tube from jug and insert into 1 gallon (5 L) of fresh water. Siphon water at low pressure for one minute.

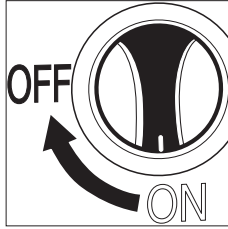

**Step 2**  
Turn the switch to off (OFF) position and unplug cord from outlet.

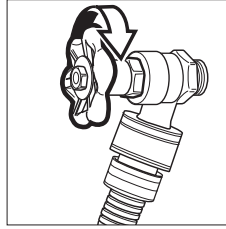

**Step 3**  
Turn off the water source.

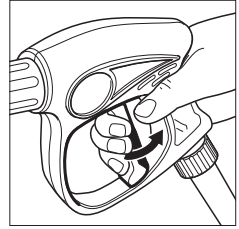

**Step 4**  
Press trigger to release water pressure.

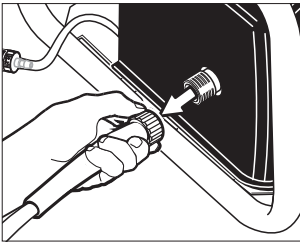

**Step 5**  
Disconnect the garden hose from the water inlet on the unit.

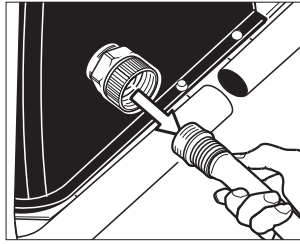

**Step 6**  
Disconnect the high pressure hose from the high pressure outlet and engage the gun safety lock.

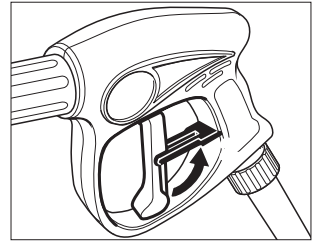

8

## TAKING A BREAK... five minutes or more

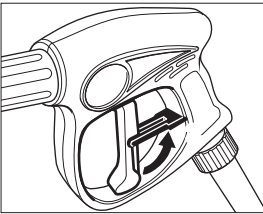

**Step 1**  
Engage gun safety lock.

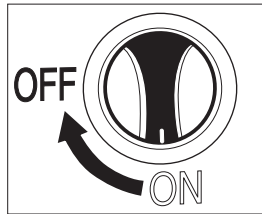

**Step 2**  
Turn pressure washer to off (OFF) position.

## WINTERIZING AND LONG-TERM STORAGE

1. Disconnect all water connections.
2. Turn on the machine for a **few seconds**, until the water which had remained in the pump exits. Turn off immediately.
3. Do not allow high pressure hose to become kinked.

4. Store the machine and accessories in a room which does not reach freezing temperatures. **DO NOT** store near furnace or other sources of heat as it may dry out the pump seals.

**Caution: Failure to follow the above directions will result in damage to the pump assembly and accessories.**



## OPTIONAL CLEANING

*Optional cleaning accessories are available to further enhance your cleaning capabilities:*

- Rotating Wash Brush
- .033 Dirt Blaster Attachment
- Extension Wands
- Pipe Drain Cleaner
- Sandblasting Attachment
- Water Filter
- Extension Hoses

## KÄRCHER 1 YEAR WARRANTY

Kärcher Canada Inc. warrants to the original owner that this product shall be free from defects in material and workmanship for **one year** from the date of its original purchase. If such a defect appears during the warranty period, upon presentation of proof of purchase, Kärcher Canada Inc. will repair or replace (at its option) your product without charge.

This warranty does not cover accidental damage, unreasonable use, normal wear and tear, loss of use or other consequential damages, nor does it cover repairs made or attempted by unauthorized persons.

Wear items such as nozzle, hose, spray wands and other accessories are warranted for **3 months**.

Please note that no returns will be accepted without prior authorization from our customer service department.

It is the owner's responsibility to file claims for damage caused by public transportation carriers directly with the carrier concerned.

# TROUBLESHOOTING

**Disconnect the machine from the power source before making any repair.**

Symptom	Cause	Solution
Motor will not start.	On/Off switch is in the "OFF" position.	Turn switch to the "ON" position.
	Power cord is not plugged in.	Plug in power cord.
	Extension cord is too long. Extension cord is not proper gauge. Extension cord is damaged.	Replace extension cord with either a 25 ft. 12/2 gauge cord or a 50 ft. 10/2 gauge cord.
	Electrical outlet does not supply adequate power.	Try a different outlet.
Unit does not reach high pressure.	Diameter of garden hose is too small.	Replace with a 1/2 inch or 5/8 inch garden hose.
	Water supply is restricted.	Check garden hose for kinks, leaks and blockage.
	Not enough inlet water supply.	Open water source full force.
	Water inlet filter is clogged.	Remove filter and rinse out in warm water.
	Triple nozzle is in low pressure position.	Turn triple nozzle to high pressure position.
Output pressure varies high and low.	Not enough inlet water supply.	Turn water on full force. Check garden hose for kinks, leaks or blockage.
	Pump is sucking air.	Check that hoses and fittings are air tight. Turn off machine and purge pump by squeezing trigger gun until a steady flow of water emerges through the nozzle.
	Water inlet filter is clogged.	Remove filter and rinse out in warm water.
	Discharge nozzle is obstructed.	Blow out or remove debris with a fine needle.
	Calcified gun, hose or power nozzle.	Run distilled vinegar through detergent tank.

## TROUBLESHOOTING – *continued*

Symptom	Cause	Solution
<b>No detergent.</b>	Detergent is too thick.	Dilute detergent.
	Filter on detergent suction tube is clogged.	Run warm water through filter to remove debris.
	Damaged or clogged detergent suction tube.	Remove obstruction or replace detergent suction tube.
	Triple nozzle is in high pressure position.	Turn nozzle tip to low pressure position.
	Discharge nozzle is obstructed.	Blow out or remove debris with a fine needle.
<b>Garden hose connection leaks.</b>	Loose fittings.	Tighten fittings.
	Missing/worn rubber washer.	Insert new washer.
<b>Spray wand leaks.</b>	Spray wand not properly attached.	Slide the spray wand into the trigger gun. Turn the wand collar clockwise onto the gun threads until tight.
	Broken o-ring or plastic insert.	Call Customer Service.
<b>Pump is noisy.</b>	Pump is sucking air.	Check that hoses and fittings are air tight. Turn off machine and purge pump by squeezing trigger gun until a steady flow of water emerges through the nozzle.
<b>Water leaks from pump (up to 10 drops per minute is permissible).</b>	Loose fittings.	Check that all fittings are tight.
	Water seals are damaged or worn.	Call Customer Service.
<b>Oil Drip.</b>	Oil seals are damaged or worn.	Call Customer Service.